

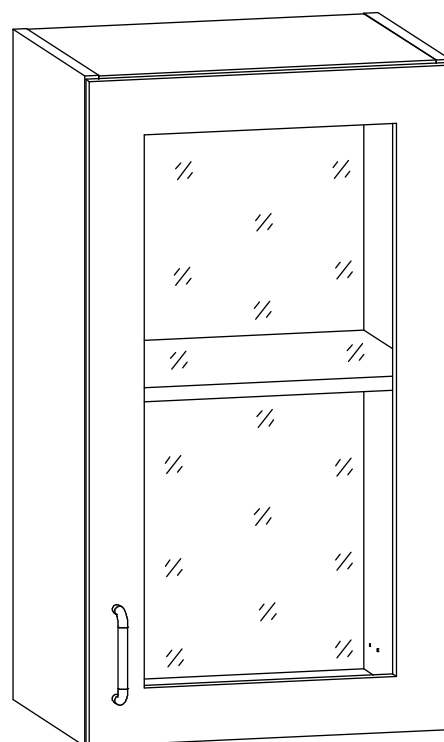

G40 / G40S

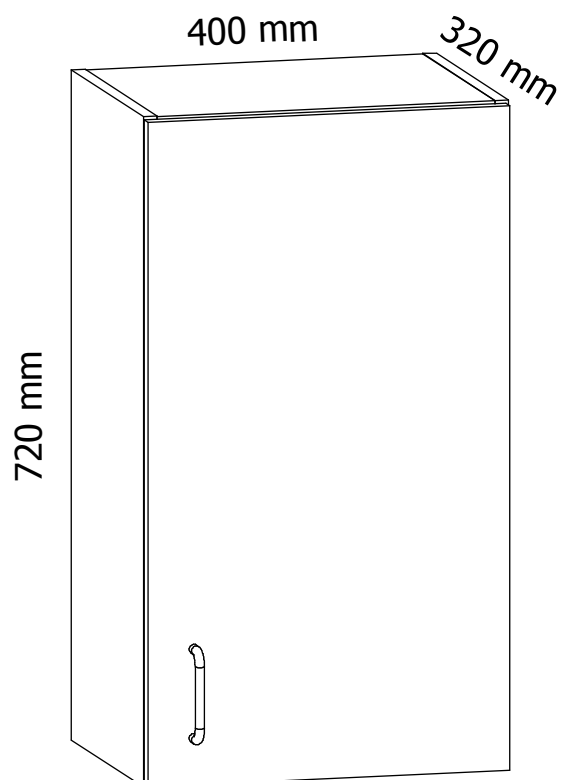
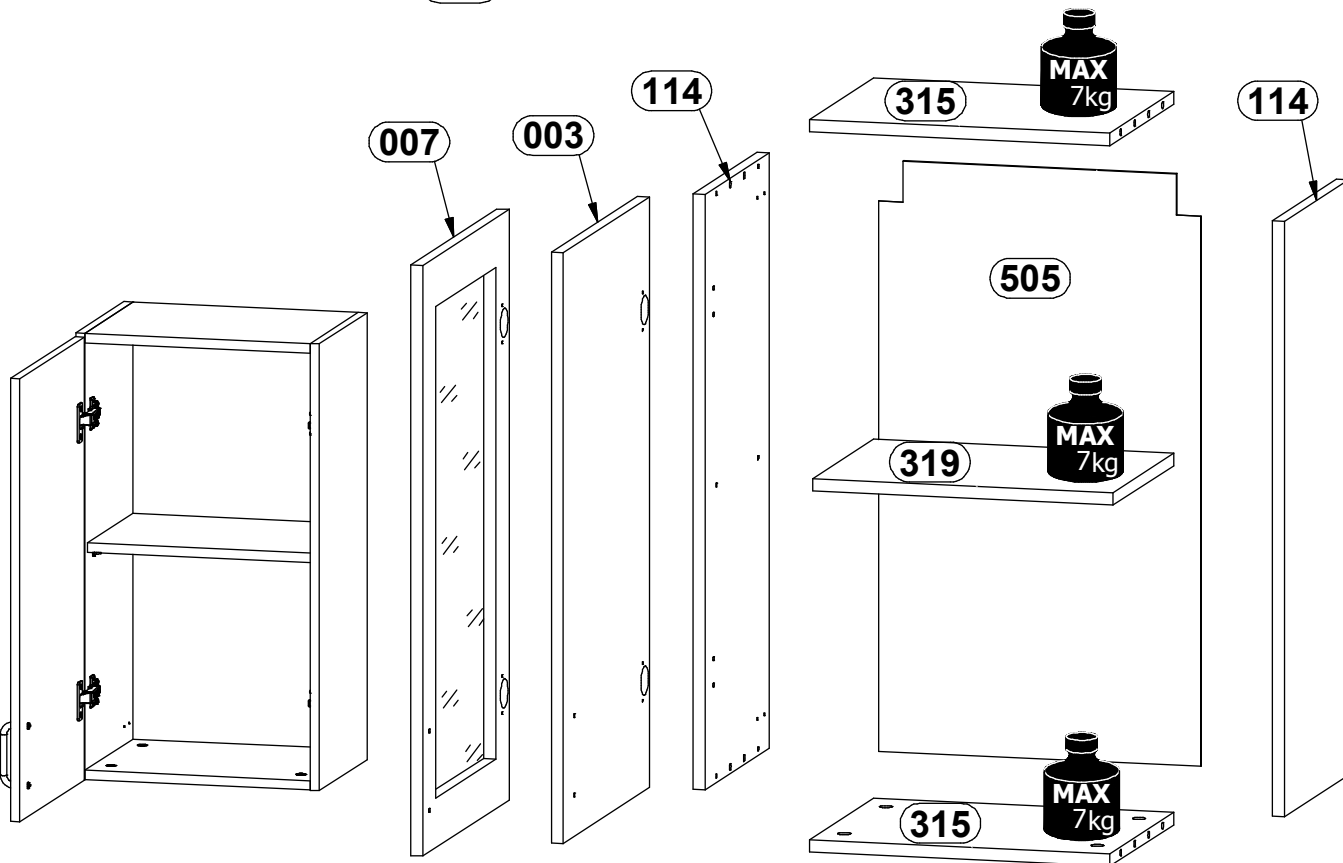
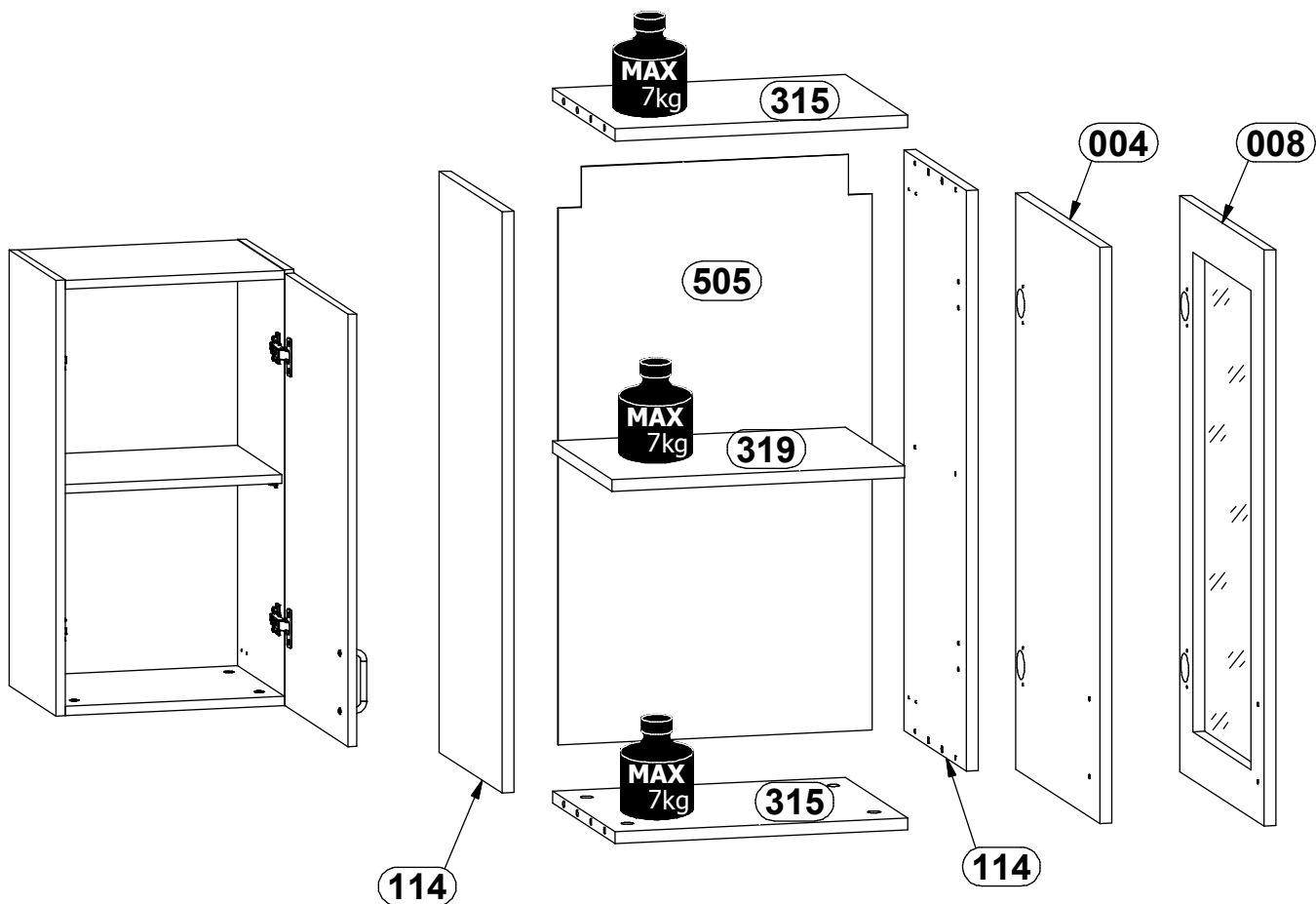

PL: INSTRUKCJA MONTAŻU
EN: ASSEMBLY MANUAL
CZ: PŘÍRUČKA PRO MONTÁŽ
SK: PRÍRUČKA PRE MONTÁŽ
DE: MONTAGEANLEITUNG
SR: UPUTSTVO ZA INSTALACIJU

G40 / G40S

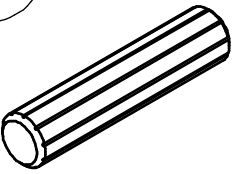
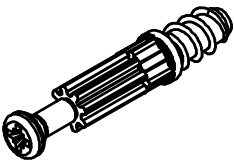
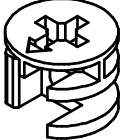
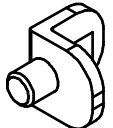
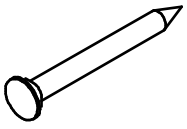
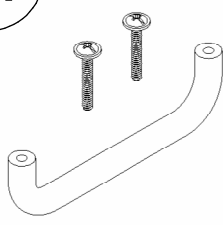
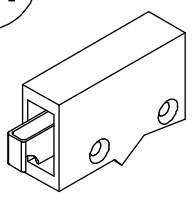
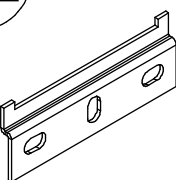
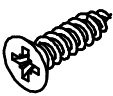
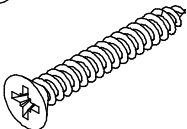

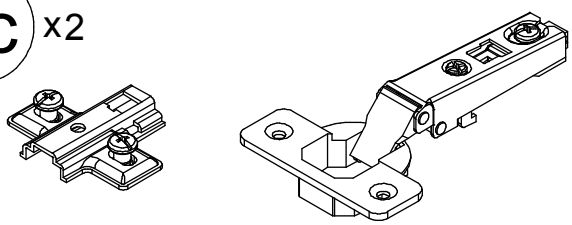
<p>A x8</p>  <p>Ø8x35mm</p>	<p>B x8</p> 	<p>C x8</p>  <p>Ø15x12mm</p>	<p>E x4</p> 
<p>G x20</p> 	<p>M x1</p> 	<p>N1 x2</p> 	<p>N2 x2</p> 
<p>W2 x4</p>  <p>Ø3,5x16</p>	<p>W8 x4</p>  <p>Ø4x30mm</p>	<p>Y x8</p>  <p>Ø18 mm</p>	
<p>Zc x2</p>  <p>Zc-1 Zc-2</p>			

1

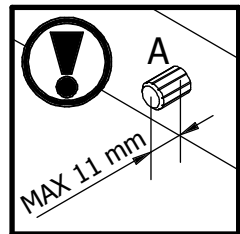
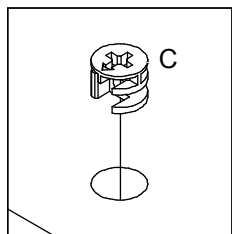
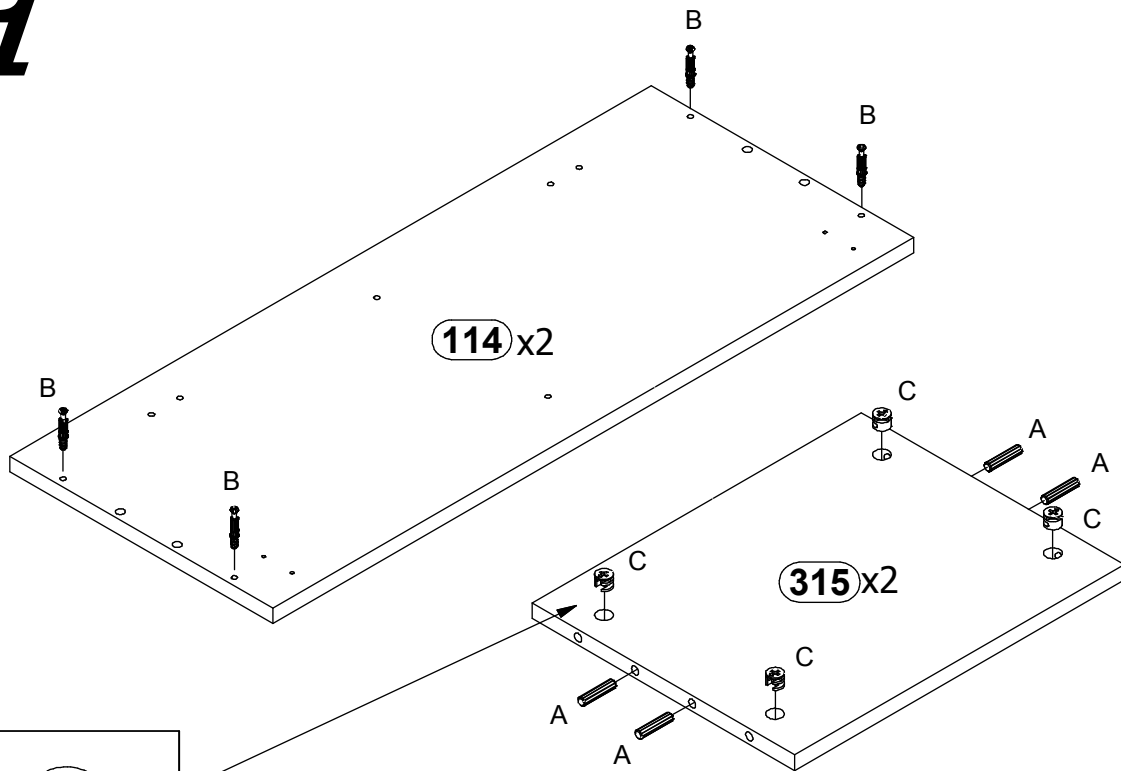
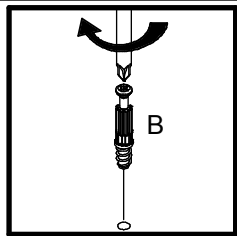

2

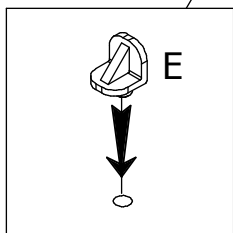
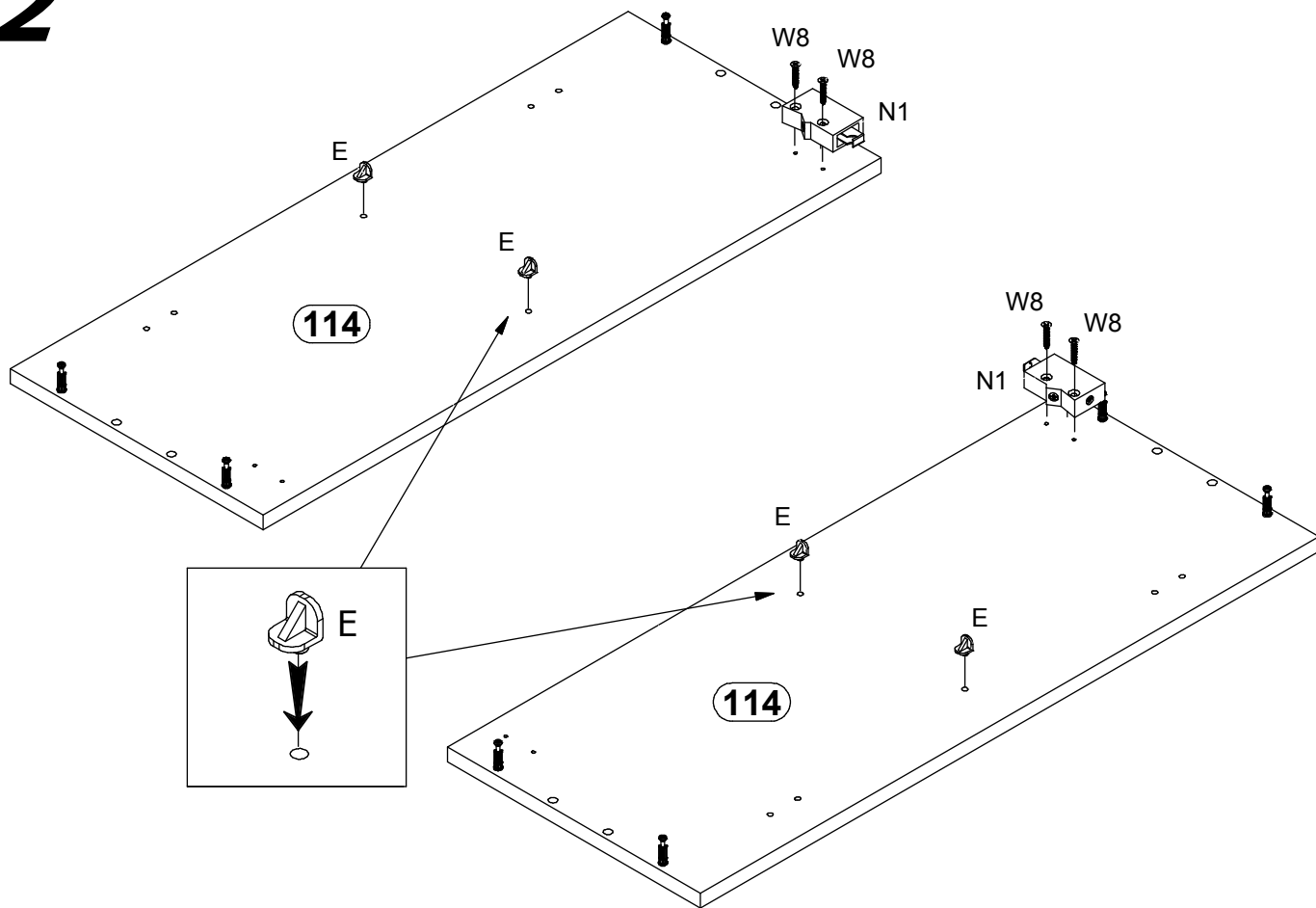

3

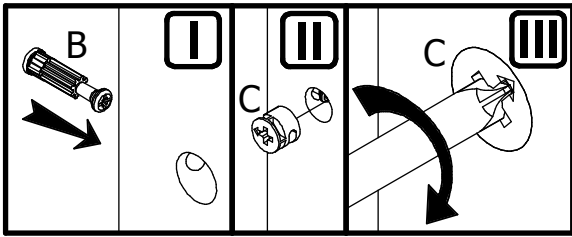
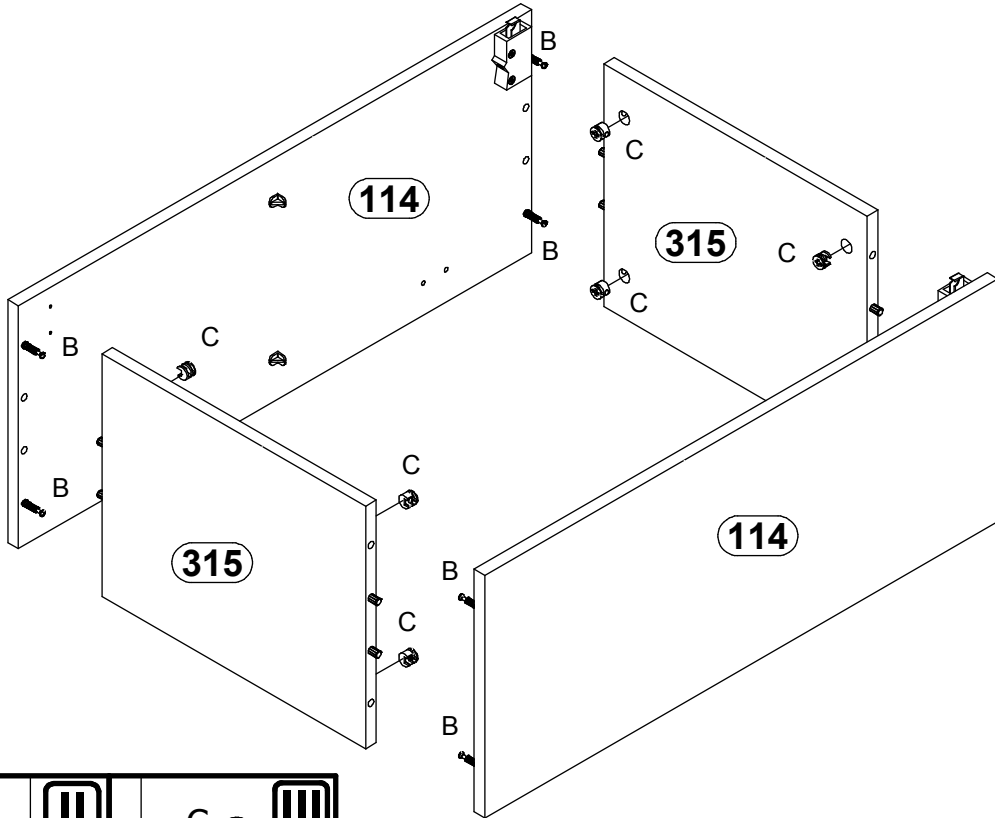

4

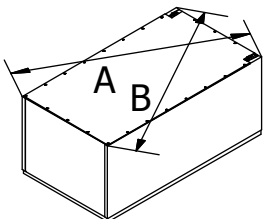
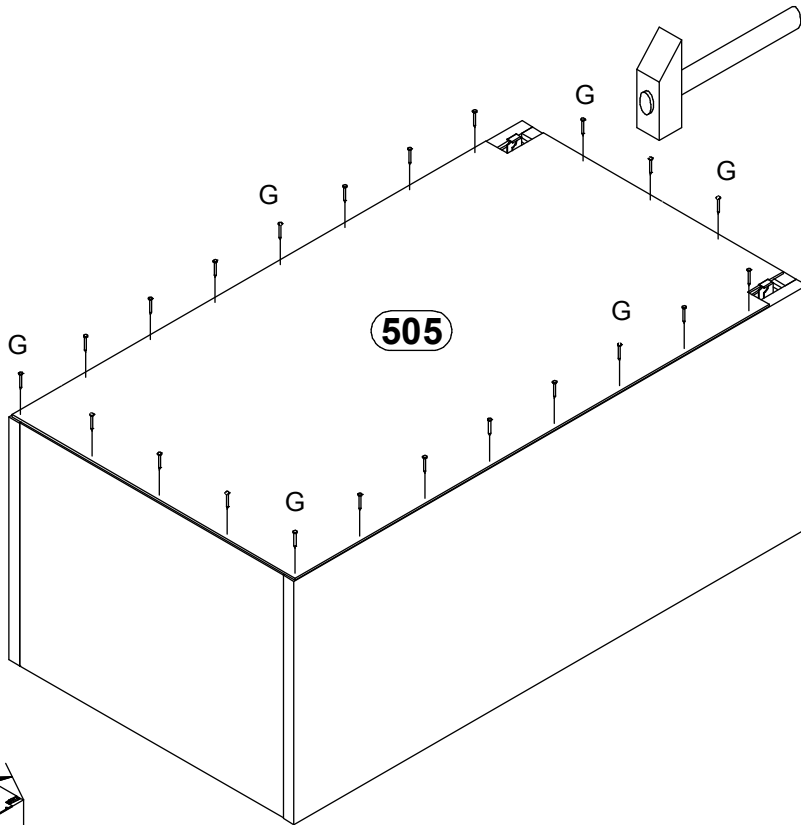

A=B

5

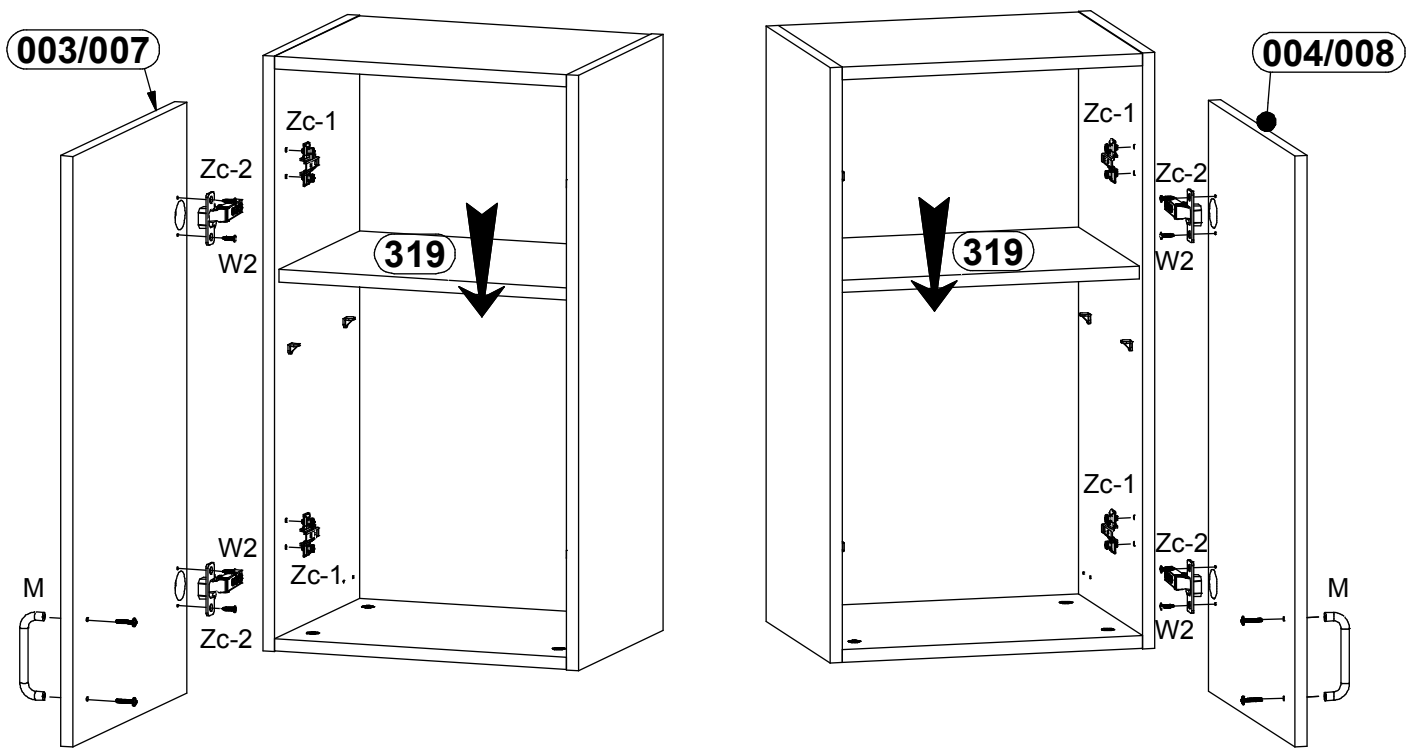

6

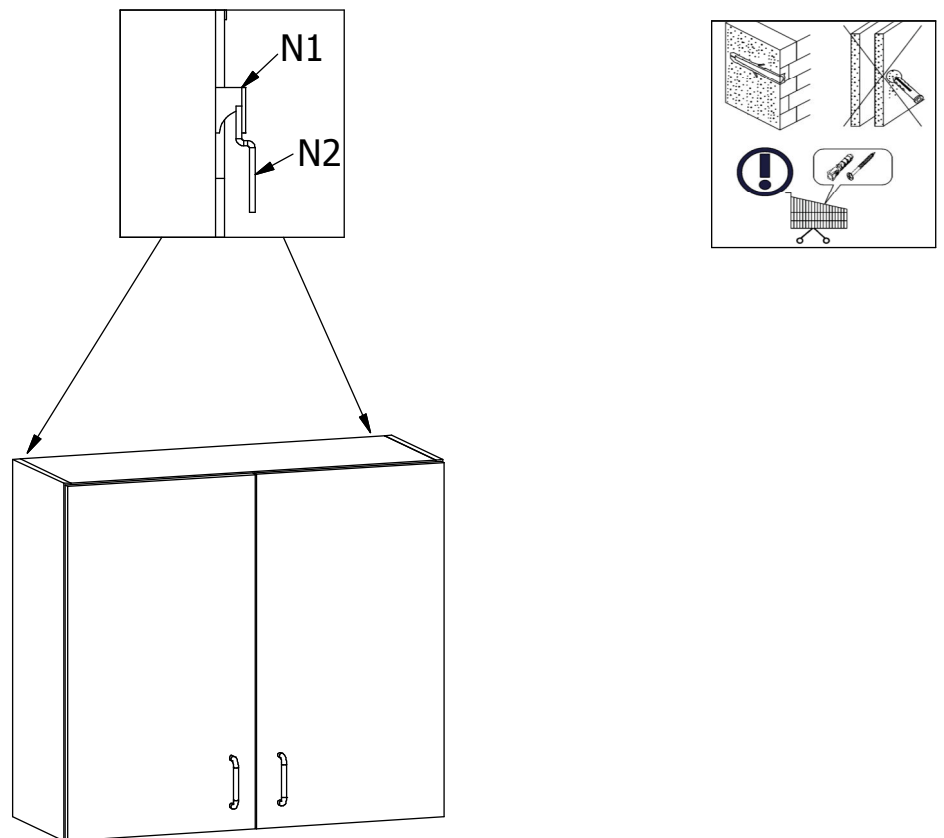

7

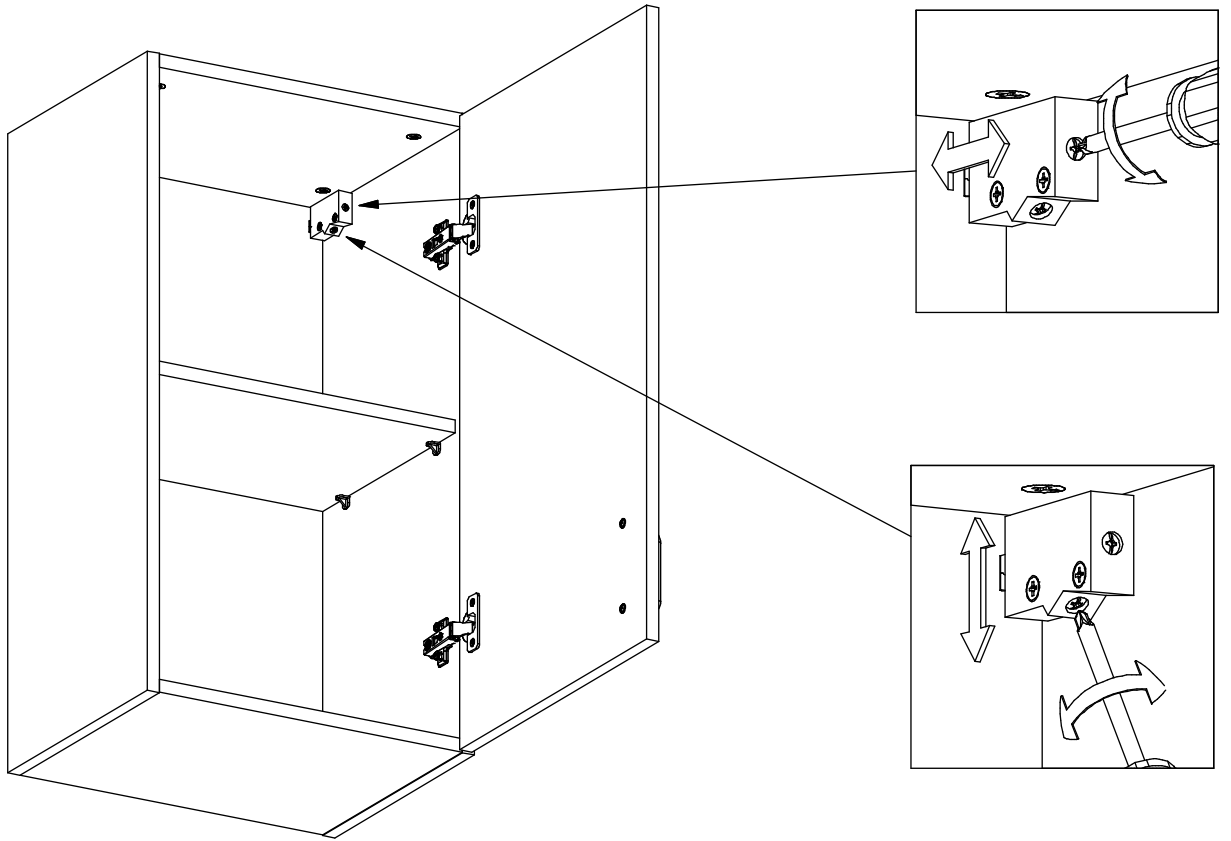

8

