

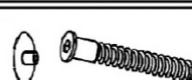





	300 mm	x1
T3		
	400 mm	x3
T4		
		x14
KF		
		x42
A1		
	6x13	x16
C2		
	3,5x13	x24
N1		
		x6
G		
	KLUCZ	x1
KLUCZ		
		x12
F1		
	15 x 12 mm	x12
E1		
		x12
E0		
		x50
G		

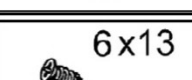
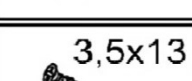

1

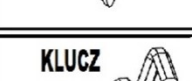

Otwory do montażu prowadnicy

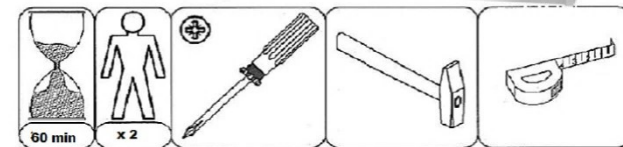
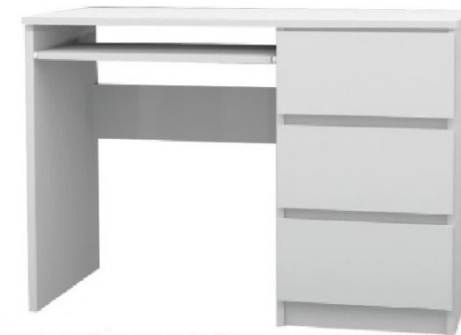
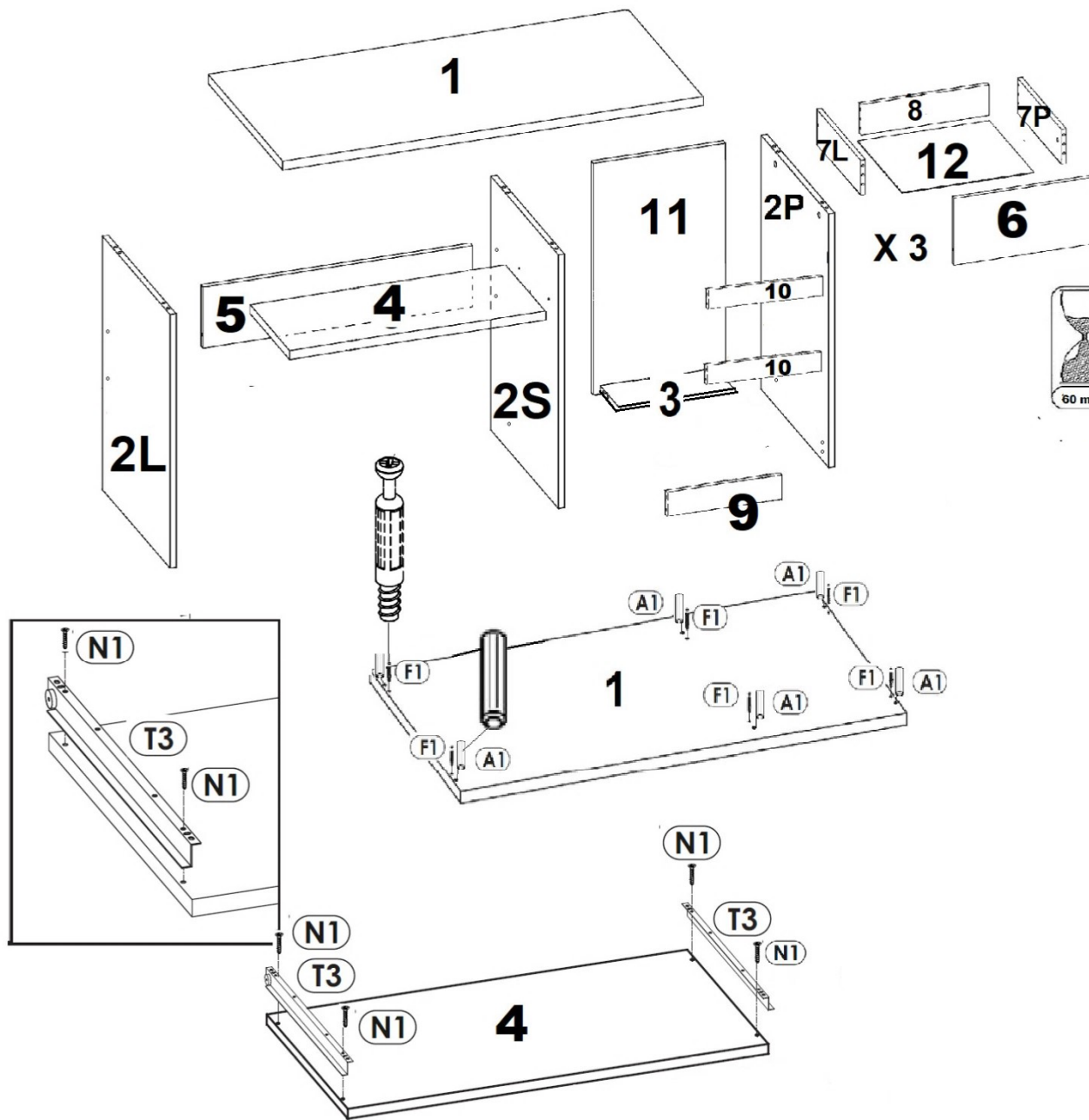
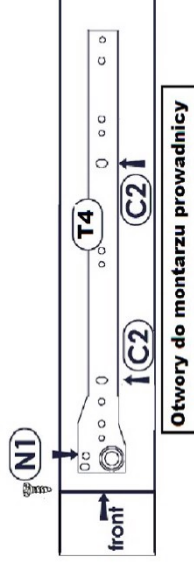
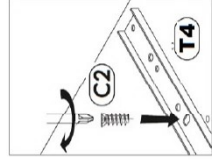
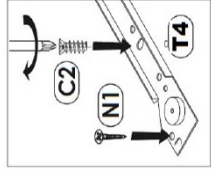
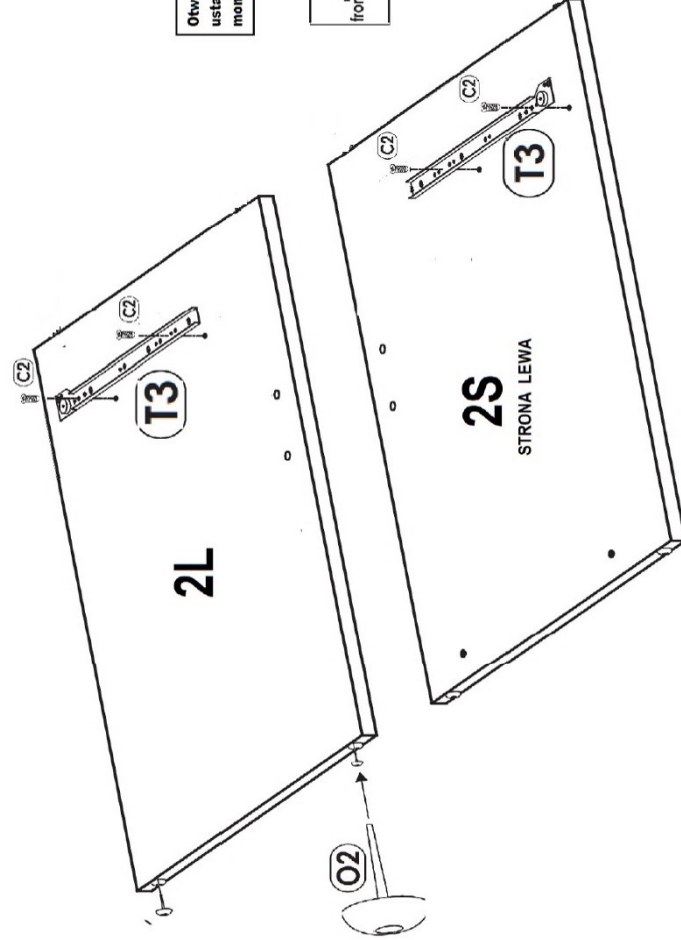
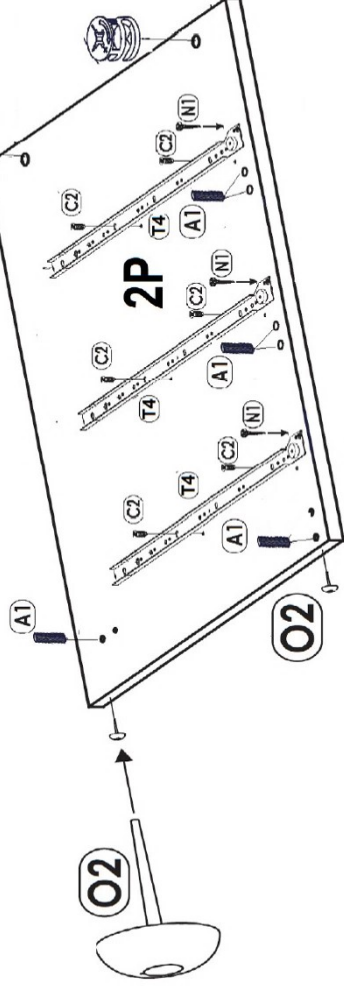
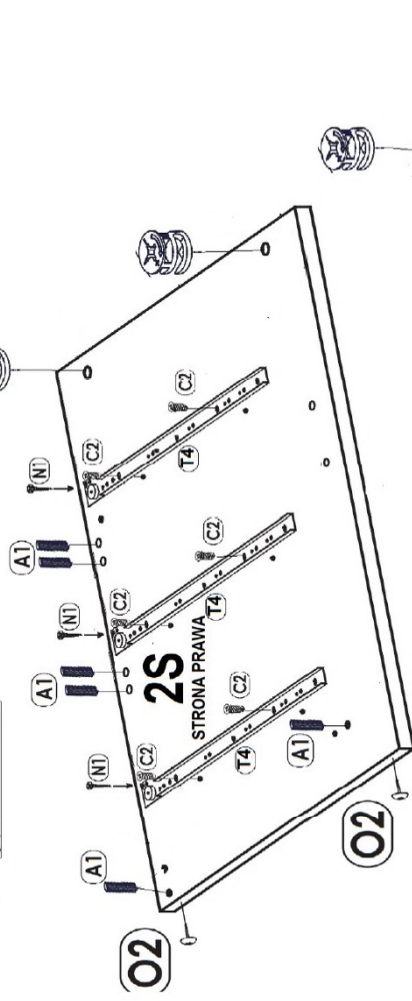

Otwór do zablokowania
ustawień prowadnicy po
montażu szuflad

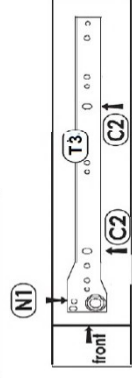

Otwory do montażu prowadnicy

