

100

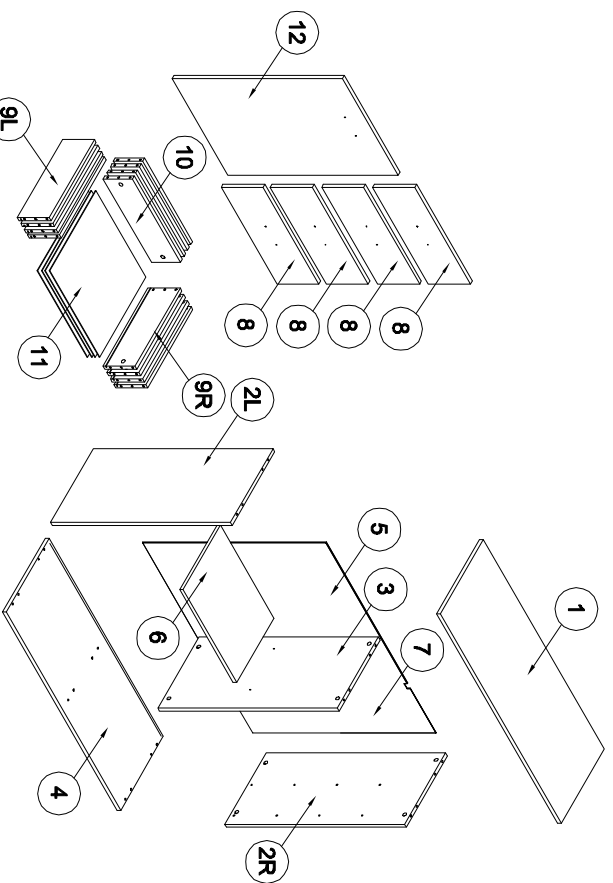

ZC	Y	W	YA	TB	TA	C	Z
○	▢	▬	⚙	⚙	⚙	⚙	○
x5	x5	x5	x10	x1	x1	x28	x28
B	A	RPS	RC	H	NB	N	X
⚙	⚙	▬	⚙	⚙	⚙	⚙	▢
x28	x44	x4	x2	x4	x24	x21	x8
PC	NA	ND	Z				
⚙	⚙	⚙	▬				
x2	x5	x24	x4				

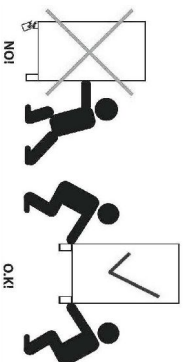
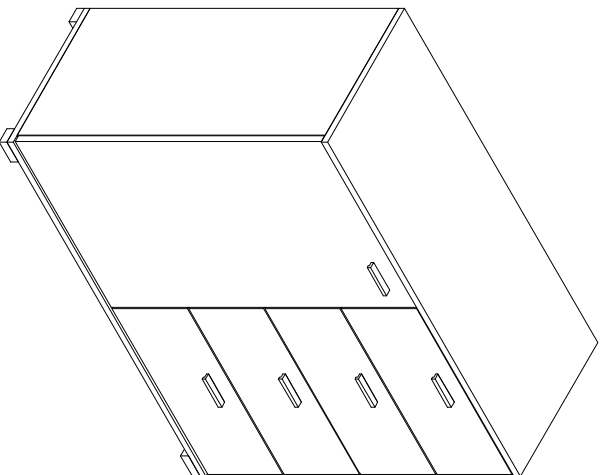
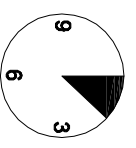
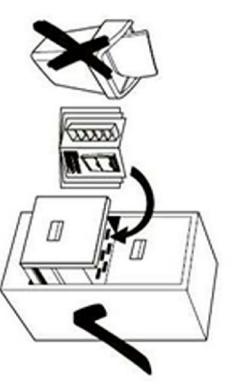
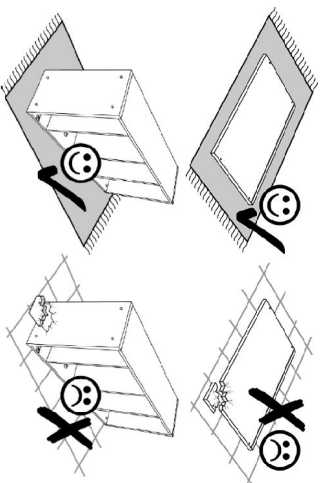

20 min.

1

2

3

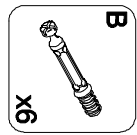
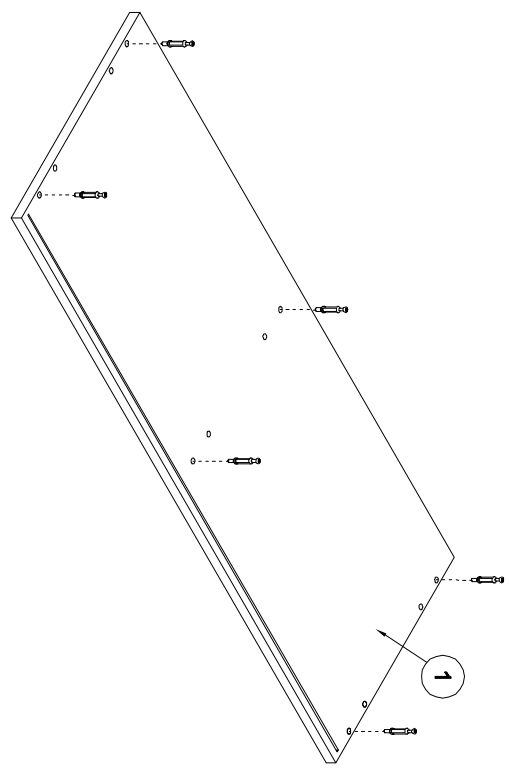
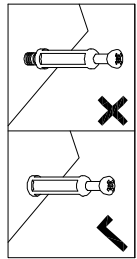

4

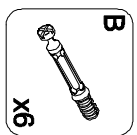
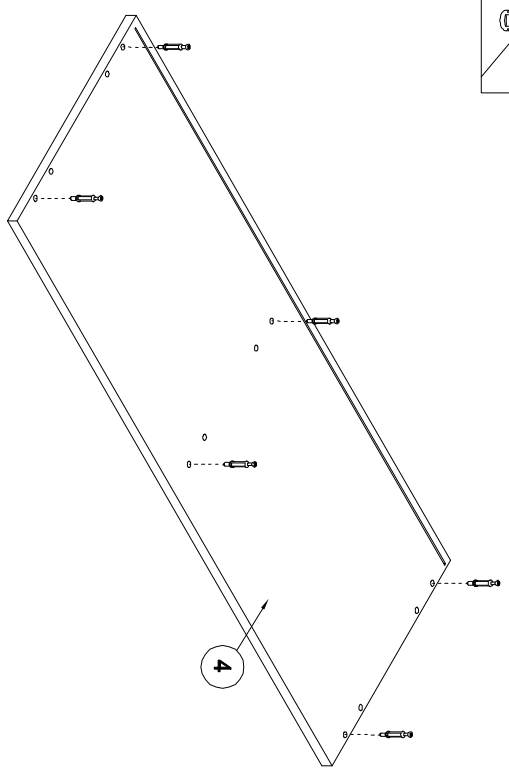
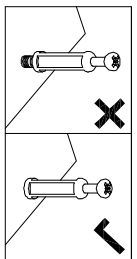

5

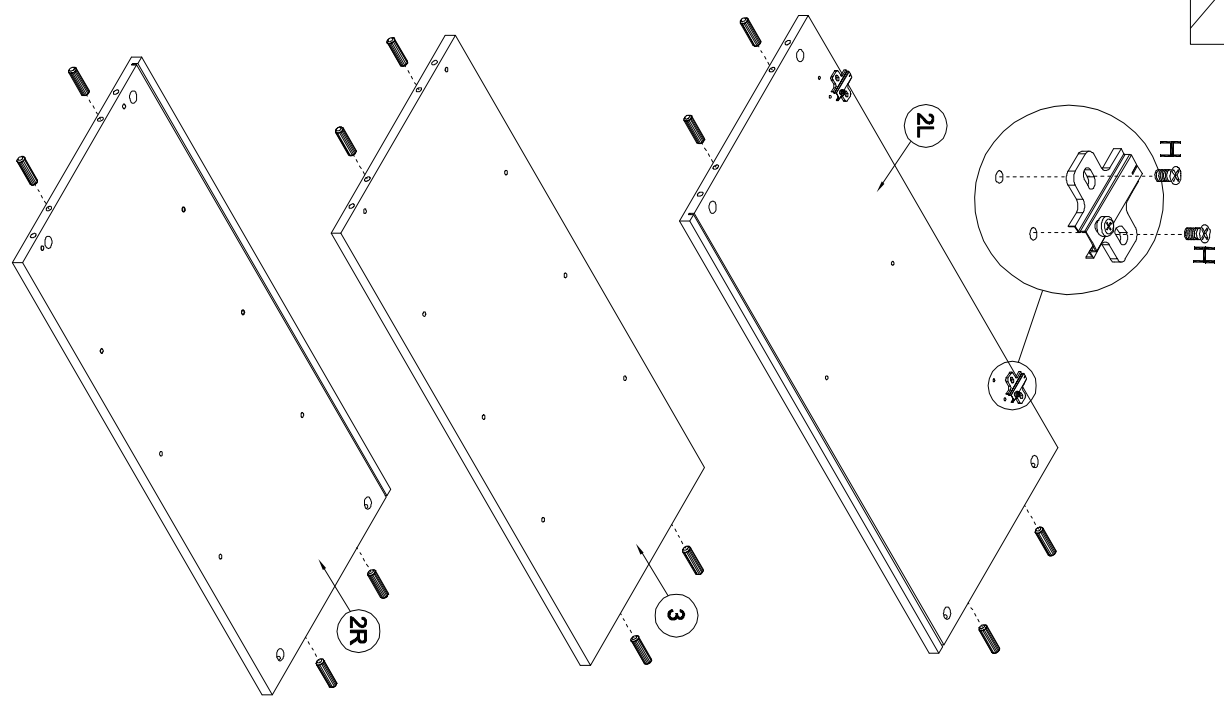
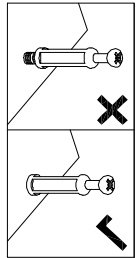

- A** 8x32 x12
- B** 6.3x13 x2
- H** 6.3x13 x4
- RC** x2

6

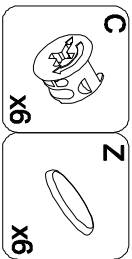
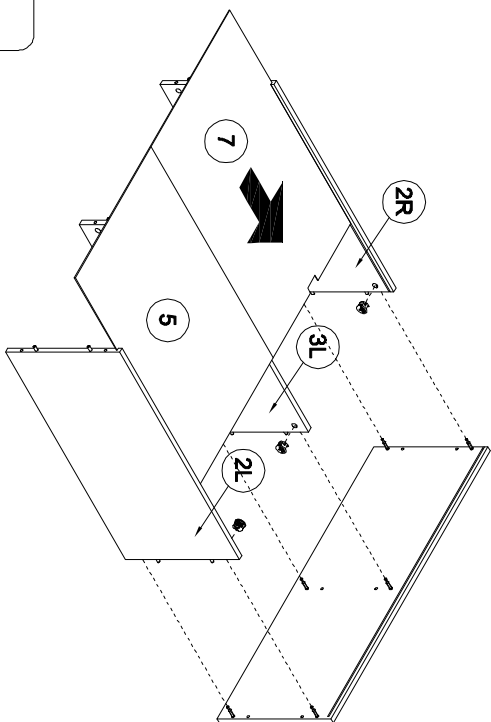
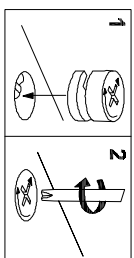

8

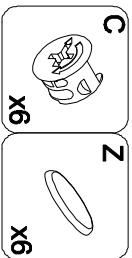
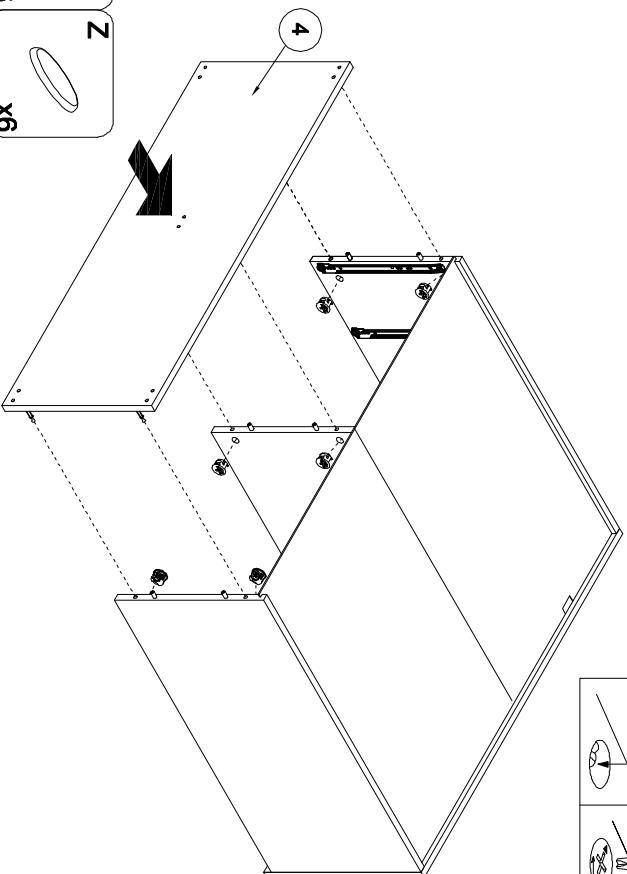
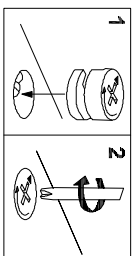

7

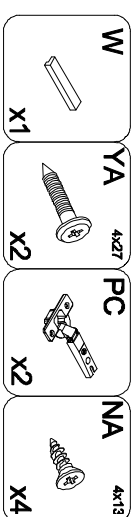
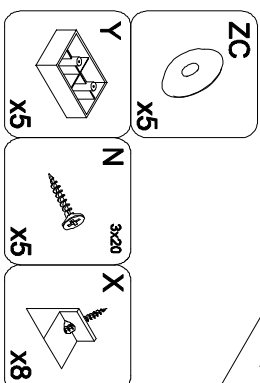
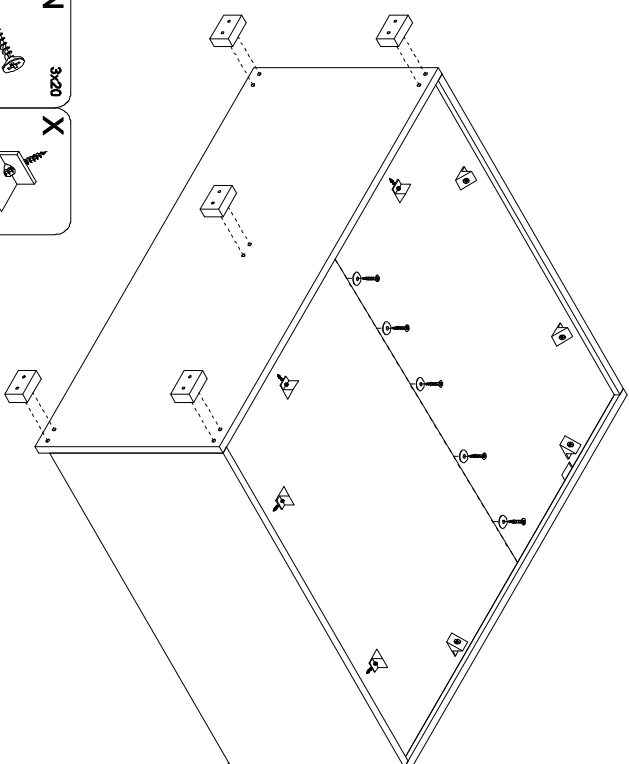

9

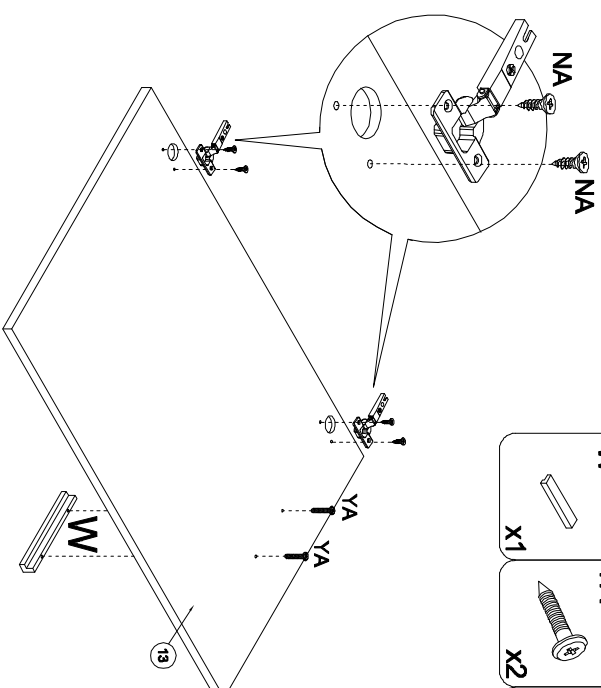

10

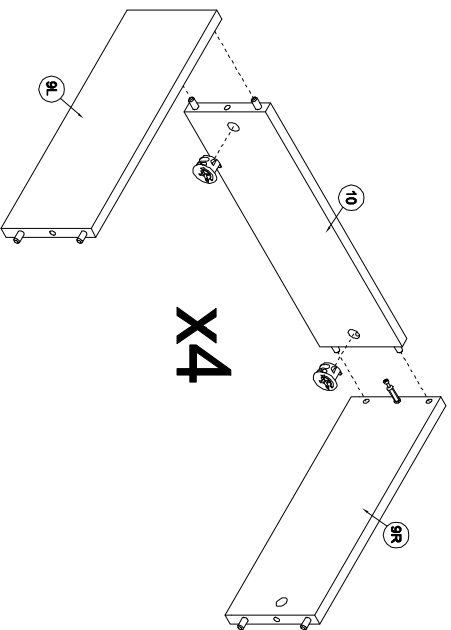
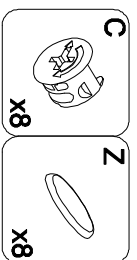
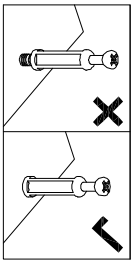
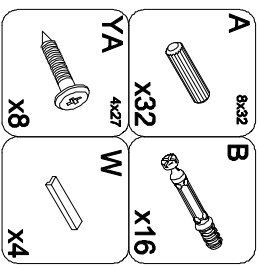
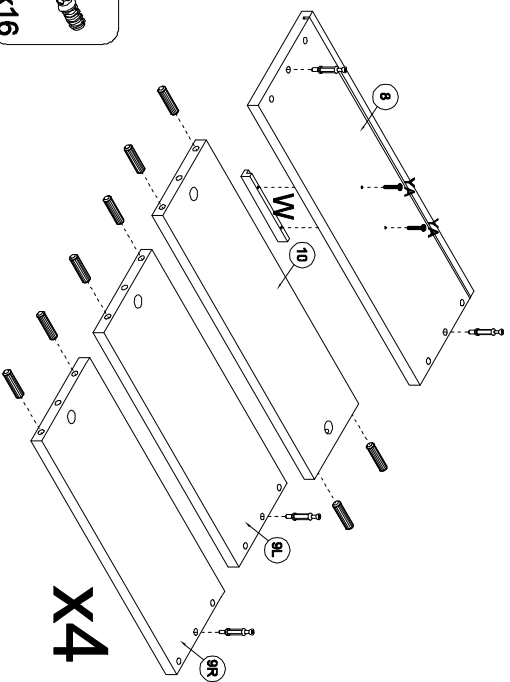

11

12

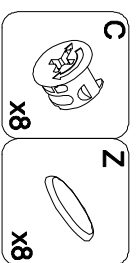
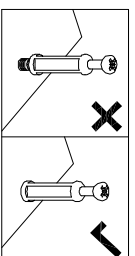
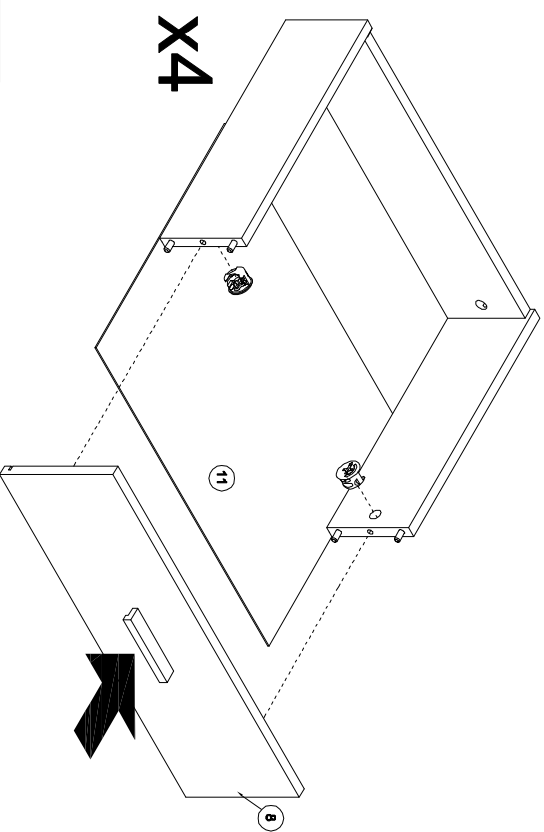

13

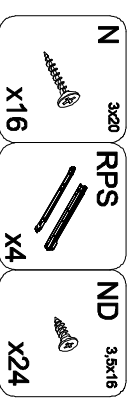
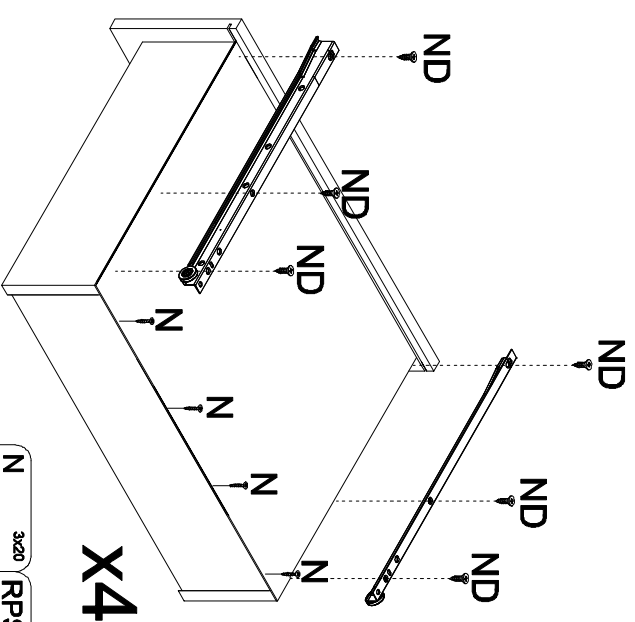

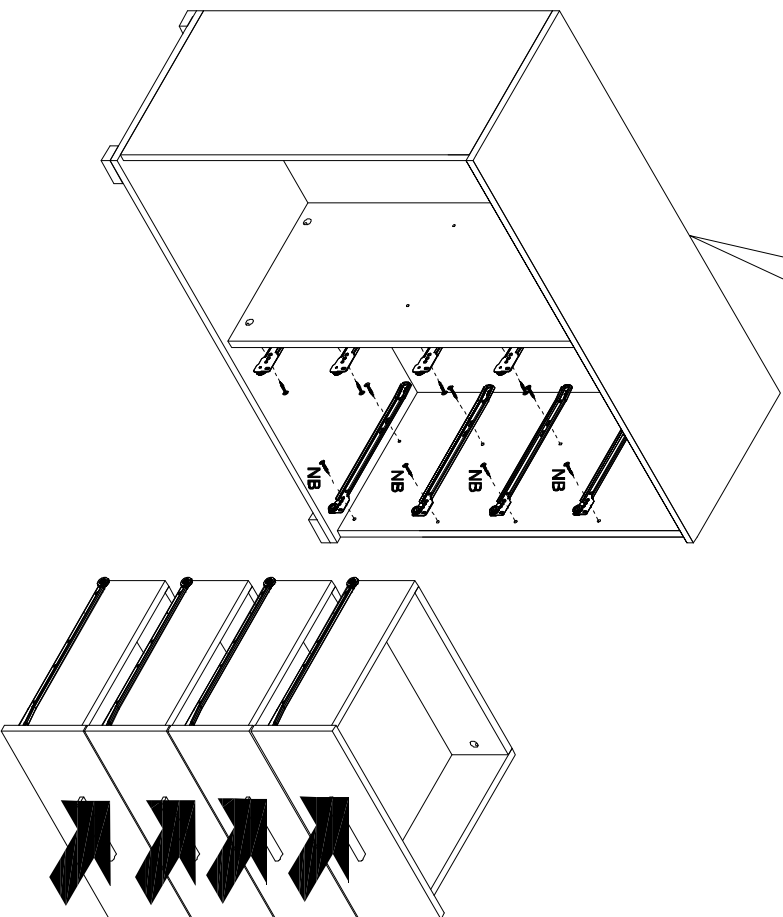
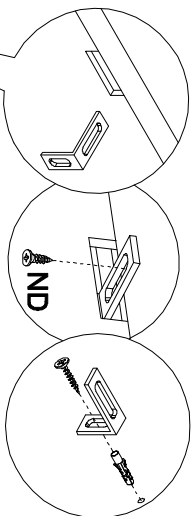

- NB 3.6x13 x24
- RPS x4
- TB x1
- TA x1
- NA 4x13 x1

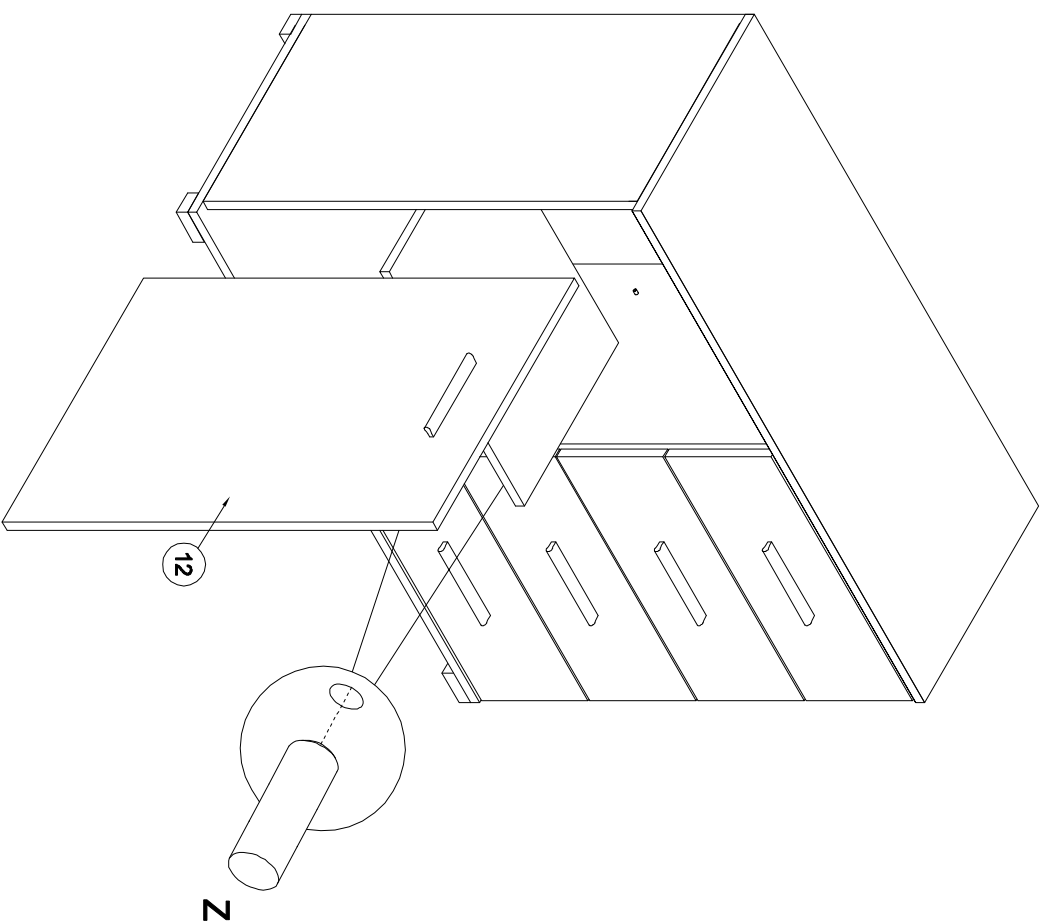
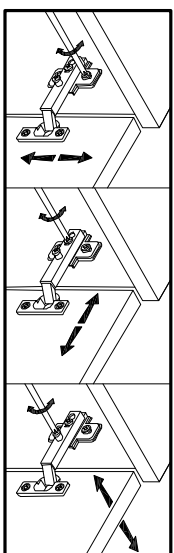

- Z x4