







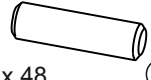

- | | | | | | |
|--|--|---|---|--|--|
| | 4x16
x 16

X | 0,9x5
x 24

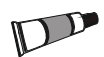
R | x 9

M | x 48

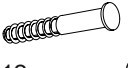
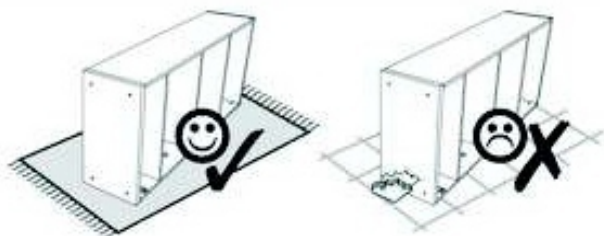
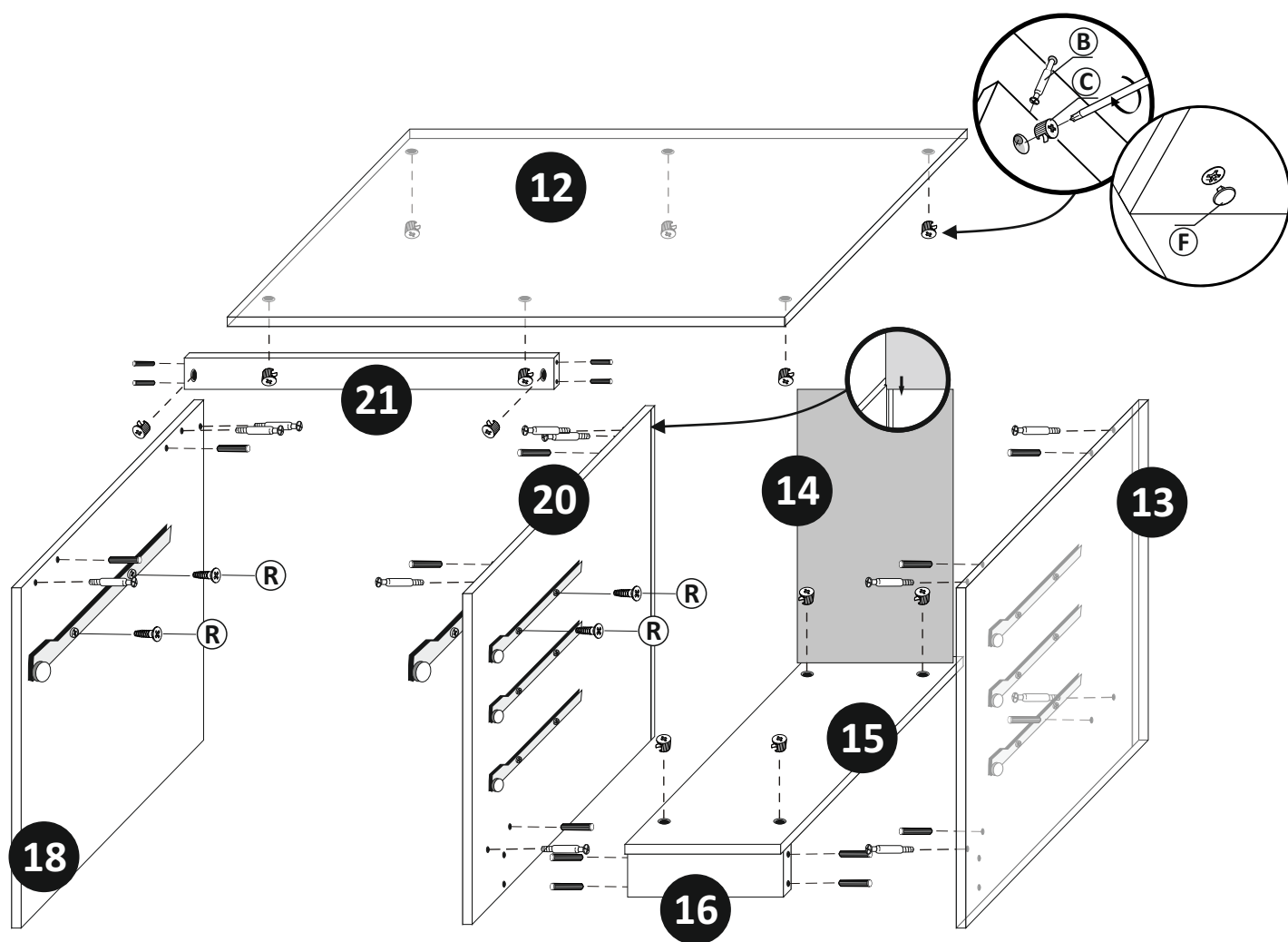
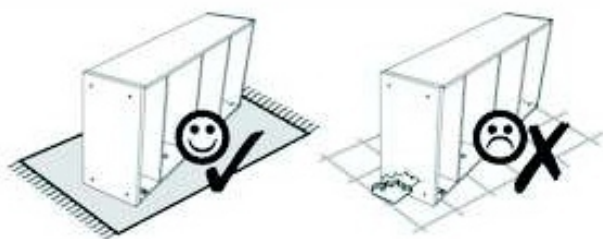
A | x 35

G |
| x 2
 | 4x30
x 6

L | x 12

F | x 12

B | x 12

C | x 12

K |



1





2

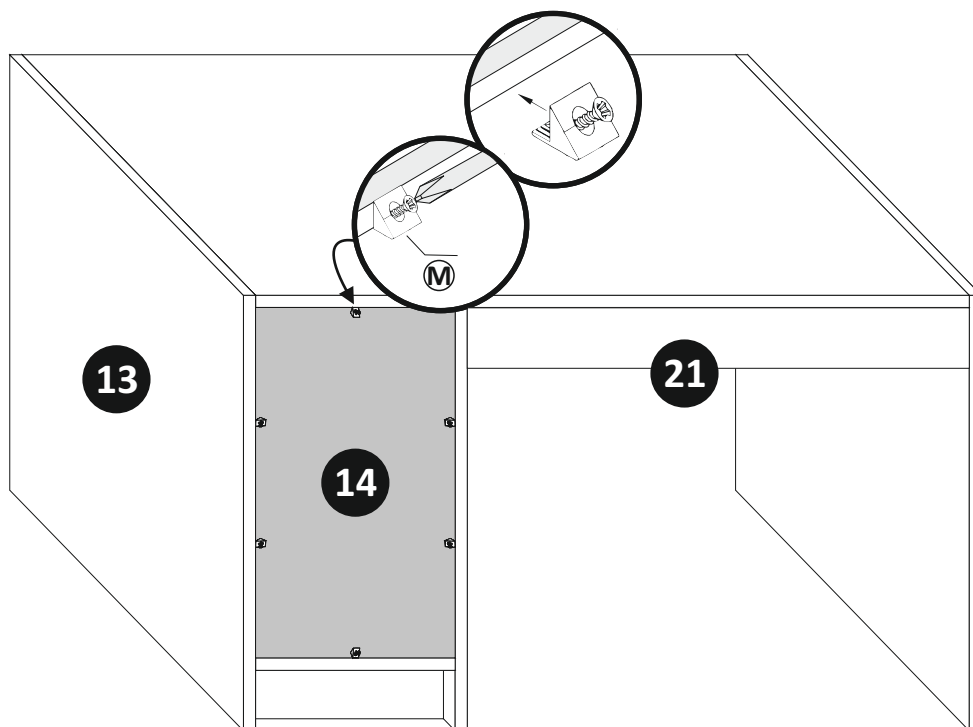

3

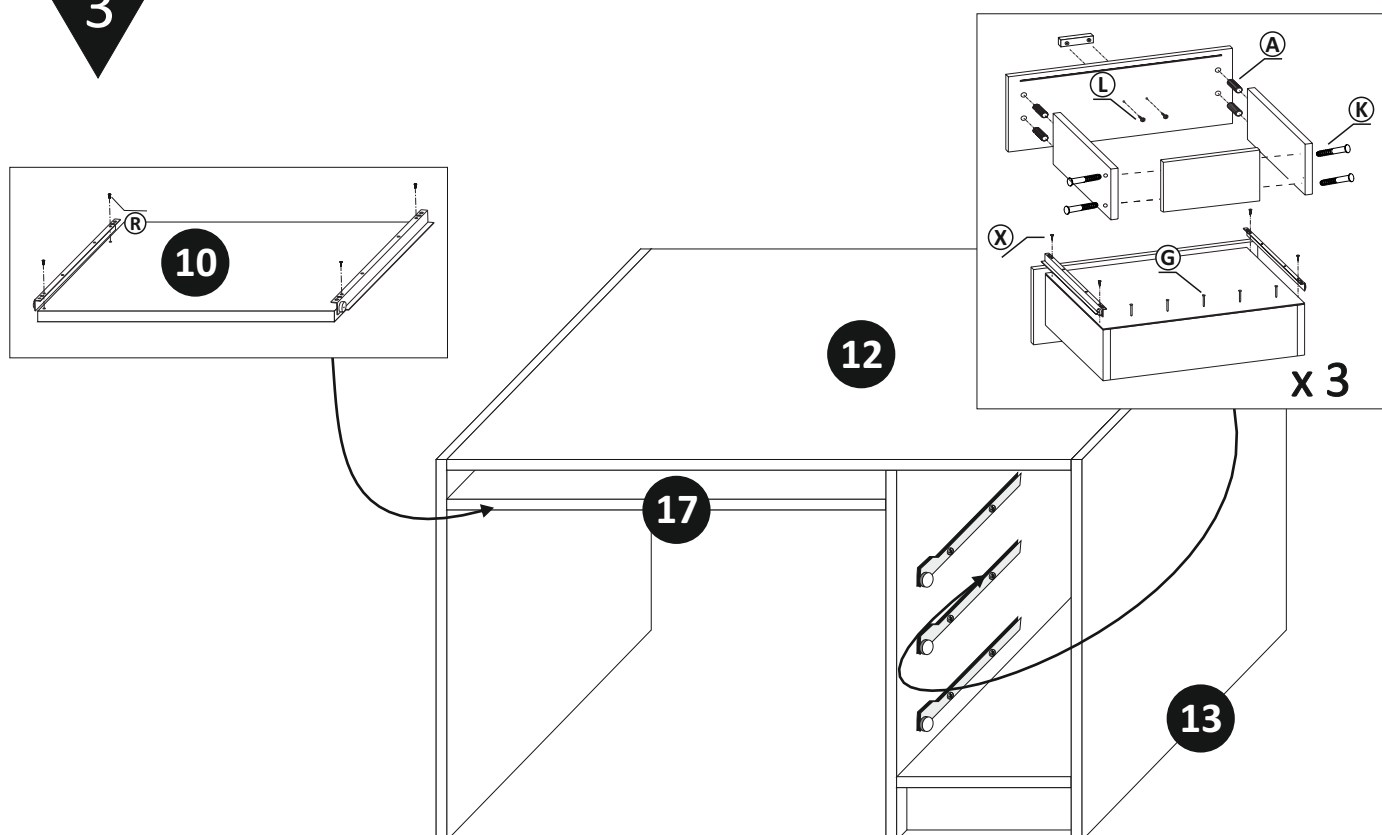

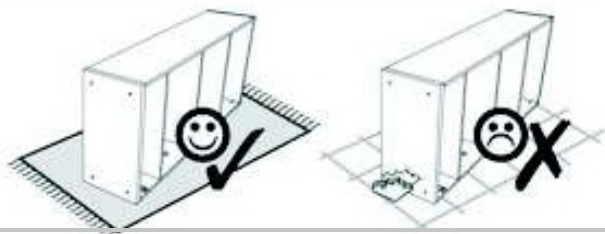

4

